

**Doshi Vakil Arts College and G.C.U.B. Science & Commerce College,  
Goregaon-Raigad**

# Welcome to University of Mumbai

**College Prospectus**

<http://dvcgoregaon.edu.in/wp-content/uploads/2023/05/Prospectus-2023-24-new.pdf>

**Online Application Portal**

**Admission  
Open**

**F.Y.B.A.**

**F.Y.B.Com.**

**F.Y.B.Sc.**

**Contact**

9028548210, 8087783220 (Commerce)  
9503002738, 9923139429 (Science)  
7038621729, 9545482101 (Arts)

**Doshi Vakil Arts College and G.C.U.B. Science & Commerce College,  
Goregaon-Raigad**

# Online Application Process of First-Year Under-Graduate Programs for Fresher Students

Online Application is mandatory for applying to any affiliated college-Program of  
Mumbai University.

**Admission  
Open**

**F.Y.B.A.**

**F.Y.B.Com.**

**F.Y.B.Sc.**

## **Contact**

9028548210, 8087783220 (Commerce)  
9503002738, 9923139429 (Science)  
7038621729, 9545482101 (Arts)

# Doshi Vakil Arts College and G.C.U.B. Science & Commerce College, Goregaon-Raigad

Keep Ready Below Documents

- Passport Size Photograph (soft copy)
- Signature (soft copy)
- Aadhar Card
- 'ABC' ID
- Cast Certificate (If required)
- 10<sup>th</sup> (SSC) Marksheet
- 12<sup>th</sup> (HSC) Marksheet
- Specially Abled Certificate (If applicable)

**Admission  
Open**

**F.Y.B.A.**

**F.Y.B.Com.**

**F.Y.B.Sc.**

## Contact

9028548210, 8087783220 (Commerce)  
9503002738, 9923139429 (Science)  
7038621729, 9545482101 (Arts)

**Doshi Vakil Arts College and G.C.U.B. Science & Commerce College,  
Goregaon-Raigad**

Visit our Portal

<https://mumoa.digitaluniversity.ac>

**College Prospectus**

<http://dvcgoregaon.edu.in/wp-content/uploads/2023/05/Prospectus-2023-24-new.pdf>

**Admission  
Open**

**F.Y.B.A.**

**F.Y.B.Com.**

**F.Y.B.Sc.**

**Contact**

9028548210, 8087783220 (Commerce)  
9503002738, 9923139429 (Science)  
7038621729, 9545482101 (Arts)

# Doshi Vakil Arts College and G.C.U.B. Science & Commerce College, Goregaon-Raigad

## Step 1: Registration

Registered Yourself  
on Portal by clicking  
on the 'Registered'  
Button

mumoa.digitaluniversity.ac

**UNIVERSITY OF MUMBAI**  
M.G.Road, Fort, Mumbai-400032, Maharashtra(India)

LOGIN SCHEDULE DASHBOARD CHATBOT

I am a New Admission seeker in this University.  
ह्या विद्यापीठात मी पहिल्यांदाच प्रवेश घेत आहे.

**Students NOT HAVING 16 Digit PRN have TO click ON "Register" button below. AFTER successful registration, LOG ON WITH registered username AND password.**  
१६ अंकी PRN नसलेल्या विद्यार्थ्यांनी "रजिस्टर" "Register" बटनवर क्लिक करावे.  
यशस्वीरीत्या नोंदणी झाल्यावर युझरनेम व पासवर्ड टाकून लॉगिन करावे.  
Use Chabot for getting solution of you query by clicking on 'Get Help' Link available above

USER NAME

Password

Forgot Username/ Password ? | [Validate Registration](#)

Login Register

Admission  
Open

F.Y.B.A.

F.Y.B.Com.

F.Y.B.Sc.

## Contact

9028548210, 8087783220 (Commerce)  
9503002738, 9923139429 (Science)  
7038621729, 9545482101 (Arts)

# Doshi Vakil Arts College and G.C.U.B. Science & Commerce College, Goregaon-Raigad

Fill out the Information  
required for Registration  
and click on the 'Accept'  
Button

### New Registration

First Name\*

Last Name / Surname\*

Relation Type\*  
 Son  Daughter  Wife

Father's / Husband's First Name\*

Mother's First Name\*

Date of Birth\*

Gender\*  
 Male  Female  Transgender

Mobile Number\*

Confirm Mobile Number\*

Email ID\*

Please click on "ACCEPT" to read and agree to our terms and conditions.  
विद्यापीठाच्या अटी व शर्ती मंजूर करण्याकरिता "ACCEPT" बटनवर क्लिक करा.



**Admission  
Open**



**F.Y.B.A.**

**F.Y.B.Com.**

**F.Y.B.Sc.**

**Contact**  
9028548210, 8087783220 (Commerce)  
9503002738, 9923139429 (Science)  
7038621729, 9545482101 (Arts)

# Doshi Vakil Arts College and G.C.U.B. Science & Commerce College, Goregaon-Raigad

Read the information given on the screen carefully, Click on the check box and the 'Agree' button.

### Candidate/Student Agreement (उमेदवार/विद्यार्थी करारनामा)

Please ensure that you have following information, required for application, ready in your hand before you proceed.

- ✓ I have soft copy of my passport size colour photograph (scanned with min.72 to max.150 dpi,[click here](#) for acceptable photograph guide).
- ✓ I have my own valid email ID.
- ✓ I have Proof of Date of Birth (D.O.B.) (Aadhaar Card, PAN card, School Leaving, Driving License)
- ✓ I have Caste Certificate / Caste validity certificate / Non Creamy Layer for Backward Class.
- ✓ I have mark-sheet/passing certificate for qualifying exam.
- ✓ I have Gazette Notification (if name on documents are different than the name in which you want to apply)
- ✓ **I confirm that I am in valid possession of above mentioned documents and I have read the prospects of academic program and I have satisfied myself that I am eligible for the said program.**
- ✓ I am submitting all the above which may include other personally identifiable information, voluntarily. I am fully aware that Colleges, University, Government, their associated agencies (MKCL) and their employees will use this information for Academic, Administrative, Research, Internal Quality Audits and Legal purposes and I am authorizing them for the same.
- ✓ I have no objection if details and updates about various career options or job opportunities are sent to my mobile number or email ID.

**I authorize University to send text messages to my cell phone from time to time to convey academic and administrative information.**

I have read the prospectus and rules about admission, thus clicking the below 'Agree' button.

Admission  
Open

F.Y.B.A.

F.Y.B.Com.

F.Y.B.Sc.

## Contact

9028548210, 8087783220 (Commerce)  
9503002738, 9923139429 (Science)  
7038621729, 9545482101 (Arts)

# Doshi Vakil Arts College and G.C.U.B. Science & Commerce College, Goregaon-Raigad

Enter the one-time Password received on your mobile and click on the 'Verify' button

✖Your Mobile OTP verification is pending. Kindly click on "Validate Your Registration" link to verify Mobile OTP.

Please enter your User Name and One Time Password mentioned in SMS to Validate Your Registration

OTP has been sent on Mobile No. : 9309947266

User Name

D23CQ0002314

One Time Password

One Time Password

Verify

Resend OTP

Admission  
Open

F.Y.B.A.

F.Y.B.Com.

F.Y.B.Sc.

## Contact

9028548210, 8087783220 (Commerce)  
9503002738, 9923139429 (Science)  
7038621729, 9545482101 (Arts)



# Doshi Vakil Arts College and G.C.U.B. Science & Commerce College, Goregaon-Raigad

Now set your own  
Password and the  
Registration  
Process is  
Completed.

Please enter new password and confirm password.

New Password	<input type="password" value="New Password"/>	<input type="password" value="Password"/>
Confirm Password	<input type="password" value="Confirm Password"/>	
	<input type="button" value="Set Password"/>	

**Admission  
Open**



**F.Y.B.A.**

**F.Y.B.Com.**

**F.Y.B.Sc.**

## Contact

9028548210, 8087783220 (Commerce)  
9503002738, 9923139429 (Science)  
7038621729, 9545482101 (Arts)

# Doshi Vakil Arts College and G.C.U.B. Science & Commerce College, Goregaon-Raigad

Now log in with your  
own user Id and  
password



**UNIVERSITY OF MUMBAI**  
M.G.Road, Fort, Mumbai-400032, Maharashtra(India)

LOGIN SCHEDULE CHATBOT LIST OF COLLEGES COLLEGE-PROGRAM LIST

I am a New Admission seeker  
in this University.  
ह्या विद्यापीठात मी पहिल्यांदाच प्रवेश  
घेत आहे.

**i** Students NOT HAVING 16 Digit PRN have TO click ON "Register" button below. AFTER successful registration, LOG ON WITH registered username AND password. १६ अंकी PRN नसलेल्या विद्यार्थ्यांनी "रजिस्टर" "Register" बटनवर क्लिक करावे." यशस्वीरीत्या नोंदणी झाल्यावर युझरनेम व पासवर्ड टाकून लॉगिन करावे.  
**Use Chabot for getting solution of you query by clicking on 'Get Help' Link available above**

[Forgot Username/ Password ?](#) | [Validate Registration](#)

Login Register

**Admission Open** → **F.Y.B.A.** **F.Y.B.Com.** **F.Y.B.Sc.**

**Contact**  
9028548210, 8087783220 (Commerce)  
9503002738, 9923139429 (Science)  
7038621729, 9545482101 (Arts)

# Doshi Vakil Arts College and G.C.U.B. Science & Commerce College, Goregaon-Raigad

Step 2: Complete Profile  
Click on the Fill Profile button

The screenshot shows the PARAG portal interface for the University of Mumbai. The header includes the university logo and name, along with the address: M.G. Road, Fort, Mumbai-400032, Maharashtra(India). The user is logged in as 'PARAG'. The main content area displays a 'Welcome PARAG!' message and a notification about profile details. Below this, there are six colored buttons for profile sections: PersonalDetails (red), Address (green), Education (teal), Reservation (blue), PhotoSign (purple), and Contact (dark purple). A 'Profile Progress' section shows a donut chart with a 'Fill Profile' button highlighted by a yellow arrow. The footer contains copyright information for Maharashtra Knowledge Corporation Limited.

Admission  
Open

F.Y.B.A.

F.Y.B.Com.

F.Y.B.Sc.

**Contact**  
9028548210, 8087783220 (Commerce)  
9503002738, 9923139429 (Science)  
7038621729, 9545482101 (Arts)

# Doshi Vakil Arts College and G.C.U.B. Science & Commerce College, Goregaon-Raigad

Fill out  
Personal details

☰ Personal Details

Applicant Name Last Name SHIMPI First Name\* PARAG

Relation Type\*  Son  Daughter  Wife

Father's First Name\* SHIVAJI

Father's Name in Regional Language

Mother's First Name\* MOTHER'S FIRST NAME

Mother First Name in Regional Language\*

Please provide correct and exact name below. The same shall be appeared further on all statement of Marks and Convocation Certificate.

Applicant's Name on Statement of Marks/ Leaving Certificate\* APPLICANT'S NAME ON STATEMENT OF MARKS/ LEAVING CERTIFICATE

Name in Regional Language\*

Is your name changed after Passing qualifying examination?  
 ⓘ [Tick / Select the Check-box, if YES]

Gender  Male  Female  Transgender

Date of Birth 06/07/1984 Place Of Birth Place Of Birth

Marital Status --Select-- Mother Tongue --Select--

Religion --Select--

Nationality Details

Country of Citizenship India

Admission  
Open

F.Y.B.A.

F.Y.B.Com.

F.Y.B.Sc.

Contact

9028548210, 8087783220 (Commerce)  
9503002738, 9923139429 (Science)  
7038621729, 9545482101 (Arts)

# Doshi Vakil Arts College and G.C.U.B. Science & Commerce College, Goregaon-Raigad

Aadhar number  
and 'ABC' ID are  
Compulsory

Country of Citizenship:

Domicile of State\*:

**Other Details**

Aadhaar Number:  **AADHAR Number is mandatory for availing the benefit of various Government schemes, so ensure the CORRECTNESS of AADHAR.**

Academic Bank Of Credit (ABC ID)\*:  **If you do not have 'ABC ID', Please click on link: <https://digilocker.meripchaaan.gov.in/signup/> to create ID.**  
[view]

Is your name registered in voter list? \*  Yes  No

Voter ID:

PAN Card Number:

Education gap (in yrs):

Max Qualification in family:

Blood Group:

Willingness about organ donation after accidental death for transplantation/ Donor Card will be issued  
[Tick / Select the Check-box, if YES]

I understood what constitutes ragging and sexual harassment. I have read the guidelines related to the same. I hereby affirm that if found guilty of ragging or sexual harassment, I am liable for punishment according to the University regulations.

Admission  
Open

F.Y.B.A.

F.Y.B.Com.

F.Y.B.Sc.

## Contact

9028548210, 8087783220 (Commerce)  
9503002738, 9923139429 (Science)  
7038621729, 9545482101 (Arts)

# Doshi Vakil Arts College and G.C.U.B. Science & Commerce College, Goregaon-Raigad

Fill out the  
Address Details

Address Details

Personal Details saved successfully!

### Correspondence

Enter C/O/Fiat No/ Building Name/House Number/House Name/Block No\*

Enter Street Name/Area Name/Colony Name/Society Name/Ward Name\*

Enter Village name

Landmark

Location Area\*  Rural  Semiurban  Urban  Tribal

Select Country\*

Select State\*

Select District\*

Tehsil/Taluka\*

City\*

Pincode\*

Is permanent address same as address for correspondence (Present Address)  
[Tick / Select the Check-box, if YES]

Admission  
Open

F.Y.B.A.

F.Y.B.Com.

F.Y.B.Sc.

## Contact

9028548210, 8087783220 (Commerce)  
9503002738, 9923139429 (Science)  
7038621729, 9545482101 (Arts)

# Doshi Vakil Arts College and G.C.U.B. Science & Commerce College, Goregaon-Raigad

Fill out the  
Education Details.  
10<sup>th</sup> and 12<sup>th</sup>  
details are  
Compulsory for  
FY UG Programs

Education Details

Address saved successfully

Click on Qualifications to fill details.

Qualification	Board/University	Faculty/College Name	Passing Date	Marks / Out Of
<a href="#">Add</a> SSC/Std 10th	←			
<a href="#">Add</a> HSC/Std 12th	←			
<a href="#">Add</a> Certificate				
<a href="#">Add</a> Diploma				
<a href="#">Add</a> Graduate/Post Graduate				

Proceed

Admission  
Open

F.Y.B.A.

F.Y.B.Com.

F.Y.B.Sc.

## Contact

9028548210, 8087783220 (Commerce)  
9503002738, 9923139429 (Science)  
7038621729, 9545482101 (Arts)

# Doshi Vakil Arts College and G.C.U.B. Science & Commerce College, Goregaon-Raigad

Enter SSC  
(10<sup>th</sup>) details

### SCC Details

Board\*  Indian  Foreign

Select State\* Maharashtra

Select Board\* MAHARASHTRA STATE BOARD OF SECONDARY AND HIGHER SECONDARY EDUCATION

School / College Name\* LANA HIGHSCHOOL

Date of Result\* May 1999

Roll No / Seat No\* 2323

Marksheet No 232

If your result has Grades or Marks\*  Marks  Grades

Total Marks Obtained\* 453.00 Out of\* 650.00

Percentage\* 69.69 %

Admission  
Open

F.Y.B.A.

F.Y.B.Com.

F.Y.B.Sc.

## Contact

9028548210, 8087783220 (Commerce)  
9503002738, 9923139429 (Science)  
7038621729, 9545482101 (Arts)



# Doshi Vakil Arts College and G.C.U.B. Science & Commerce College, Goregaon-Raigad



You can Edit or Delete the details if required.

Now click on the 'Add' button to enter the 12<sup>th</sup> details

### Education Details

SSC Qualification saved successfully!

Click on Qualifications to fill details.

Qualification	Board/University	Faculty/College Name	Passing Date	Marks / Out Of	CGPA	Percentage	Edit	Delete
SSC/Std 10th	MAHARASHTRA STATE BOARD OF SECONDARY AND HIGHER SECONDARY EDUCATION	LANA HIGHSCHOOL	May 1999	453 / 650	-	69.69 %		
<input type="button" value="Add"/>	HSC/Std 12th							
<input type="button" value="Add"/>	Certificate							
<input type="button" value="Add"/>	Diploma							
<input type="button" value="Add"/>	Graduate/Post Graduate							

**Admission  
Open**

**F.Y.B.A.**

**F.Y.B.Com.**

**F.Y.B.Sc.**

## Contact

9028548210, 8087783220 (Commerce)  
9503002738, 9923139429 (Science)  
7038621729, 9545482101 (Arts)

# Doshi Vakil Arts College and G.C.U.B. Science & Commerce College, Goregaon-Raigad

- Enter and Save 12<sup>th</sup> (HSC) details accurately.

### HSC Details

Board\*  Indian  Foreign

Select State\* Maharashtra

Select Board\* MAHARASHTRA STATE BOARD OF SECONDARY AND HIGHER SECONDARY EDUCATION

Stream\* Science

School / College Name\* LANA HIGHSCHOOL

Result Status\*  Passed  Result Awaited  Failed

Roll No / Seat No\* 2323

No. of Attempts\* 1

Date of Result\* May 2023

Marksheet No 232

**Note: Please select Month and Year of exam which is printed in your Hall Ticket or Marksheet.**

If your result has Grades or Marks\*  Marks  Grades

Total Marks Obtained\* 453.00 Out of\* 650.00

Percentage\* 69.69 %

Total Marks (All Subjects – Without Practical) 345 Total Marks Out of (All Subjects – Without Practical) 550

Mathematics marks obtained 79 Marks Out Of 100

JEE Number JEE NUMBER

Admission  
Open

F.Y.B.A.

F.Y.B.Com.

F.Y.B.Sc.

## Contact

9028548210, 8087783220 (Commerce)  
9503002738, 9923139429 (Science)  
7038621729, 9545482101 (Arts)

# Doshi Vakil Arts College and G.C.U.B. Science & Commerce College, Goregaon-Raigad

Fill out the

- Reservation details
- Specially Abled details (if applicable)
- Occupation details (compulsory)

### Reservation Details

**You can select multiple Social Reservations.**

Social Reservation

Category\*

Are you belonging to Economically Weaker Section [EWS]?  
[Tick / Select the Check-box, if YES]

[Criteria for Economically Weaker Section is Gross Annual Income of the family is BELOW ₹8,00,000/- ('EIGHT LAKH ONLY)]

**Specially Abled Details**

Specially Abled

**Occupation Details**

Are you Employed or Self-Employed?  
[Tick / Select if YES]

Yes  No

Occupation of Guardian\*

Annual Income of Guardian

Is Guardian from EBC (Economic Backward Class)

Students whose family income is below defined limit, fall under EBC category. The EBC certificate issued by the competent authority is mandatory.

**Save And Proceed**

**Admission  
Open**

**F.Y.B.A.**

**F.Y.B.Com.**

**F.Y.B.Sc.**

## Contact

9028548210, 8087783220 (Commerce)  
9503002738, 9923139429 (Science)  
7038621729, 9545482101 (Arts)

# Doshi Vakil Arts College and G.C.U.B. Science & Commerce College, Goregaon-Raigad

## Upload your recent passport size photo and signature

- Click on the “click here” link to view the guidelines for uploading the images

Photo & Sign Preview

Photograph

Signature

Proceed

I have soft copy of my passport size colour photograph (scanned with min.72 to max.150 dpi, [click here](#) for acceptable photograph guide).

**Admission  
Open**

**F.Y.B.A.**

**F.Y.B.Com.**

**F.Y.B.Sc.**

### Contact

9028548210, 8087783220 (Commerce)  
9503002738, 9923139429 (Science)  
7038621729, 9545482101 (Arts)

# Doshi Vakil Arts College and G.C.U.B. Science & Commerce College, Goregaon-Raigad

Refer  
Photograph  
guide

## Acceptable Photograph Guide

1. Preferably in colour, not black and white.
2. Taken against a light grey or cream background.
3. 45 millimeters (mm) high x 35 mm wide.
4. Able to fit into the template given, with the eyes positioned in the shaded area.
5. Free from shadows.
6. Taken with the eyes open and clearly visible (with no sunglasses or tinted spectacles, and no hair across the eyes).
7. With the subject facing forward, looking straight at the camera.
8. With a neutral expression with the mouth closed (no grinning, frowning or raised eyebrows).
9. Of each person on their own (no other objects, or other people visible) taken with nothing covering the face.
10. In sharp focus and clear.
11. With a strong definition between face and background.
12. Photographs must also be a recent true likeness of the individual, taken within the last 6 months.
13. Be undamaged (not torn, creased or marked).
14. Be free from reflection or glare on spectacles.
15. Be free from "redeye".
16. Be free from airbrushing or similar enhancement (for example photographs must not be 'photoshopped' or 'touched-up' or otherwise digitally altered).
17. Be taken of the full head, without any covering unless worn for religious or medical reasons.

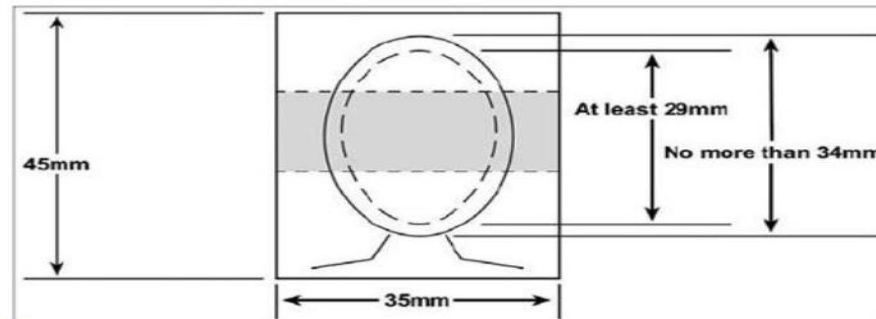

*The photographs below are for guidance only. They provide examples of acceptable photographs. Examples of unacceptable photographs are given on the following page.*



Good

Good

Good

Admission  
Open

F.Y.B.A.

F.Y.B.Com.

F.Y.B.Sc.

## Contact

9028548210, 8087783220 (Commerce)  
9503002738, 9923139429 (Science)  
7038621729, 9545482101 (Arts)

# Doshi Vakil Arts College and G.C.U.B. Science & Commerce College, Goregaon-Raigad

## Now upload your recent passport size Photo and Signature

Reservation saved successfully!

Photograph  Signature

Browse Crop Upload

Photo & Sign Preview

Photograph	Signature
Photo Not Available	Signature Not Available

Proceed

I have soft copy of my passport size colour photograph (scanned with min.72 to max.150 dpi, [click here](#) for acceptable photograph guide).

Admission  
Open



F.Y.B.A.

F.Y.B.Com.

F.Y.B.Sc.

### Contact

9028548210, 8087783220 (Commerce)  
9503002738, 9923139429 (Science)  
7038621729, 9545482101 (Arts)

# Doshi Vakil Arts College and G.C.U.B. Science & Commerce College, Goregaon-Raigad

## Provide your additional contact details

 **Contact Details**

---

**Student Contact Details**

Mobile Number\*   
Is this WhatsApp number  Yes  No

Email ID\*   
Alternate Mobile Number   
Is this WhatsApp number  Yes  No

Alternate Email ID

Area STD Code - Phone

**Parent's Contact Details**

Parent's/Guardian's Mobile Number   
Is this WhatsApp number  Yes  No

Parent's/Guardian's Email ID

**i** I hereby willfully give my agreement and consent to the University for using my aforesaid WhatsApp contact number to send me the WhatsApp messages associated with my academic progression and/or updation. I do not have any objection thereto during my academic association with this University. Further, I do hereby undertake that it will be obligatory for me to check the University's website and all sections related with my academic profile on e-Suvidha Account regularly. x

**Admission  
Open**



**F.Y.B.A.**

**F.Y.B.Com.**

**F.Y.B.Sc.**

**Contact**  
9028548210, 8087783220 (Commerce)  
9503002738, 9923139429 (Science)  
7038621729, 9545482101 (Arts)

# Doshi Vakil Arts College and G.C.U.B. Science & Commerce College, Goregaon-Raigad

## You can edit your profile before the Application

The screenshot shows the University of Mumbai student portal. The header includes the university logo, name, and address. A user profile for 'PARAG' is visible in the top right. The navigation menu includes 'DASHBOARD', 'CHATBOT', and 'ONLINE VIDEOS'. The left sidebar contains options: 'View Profile', 'Application Status', 'Edit Profile' (highlighted with a yellow arrow), 'Print e-Suvidha Ticket', and 'Update Awaited Results'. The main content area displays a welcome message 'Welcome PARAG !' and a notification about profile details. Below the notification are six profile sections: PersonalDetails, Address, Education, Reservation, PhotoSign, and Contact, each with a checkmark indicating completion. At the bottom, there are links for 'Online Application Instructions' and 'Profile Progress'.

**Admission  
Open**

**F.Y.B.A.**

**F.Y.B.Com.**

**F.Y.B.Sc.**

### Contact

9028548210, 8087783220 (Commerce)  
9503002738, 9923139429 (Science)  
7038621729, 9545482101 (Arts)



# Doshi Vakil Arts College and G.C.U.B. Science & Commerce College, Goregaon-Raigad

Click on the 'Edit Profile' button and then click on  
'Dashboard' button

☰ Edit Profile

Edit Profile is allowed only if you do not have any Complete applications. In case you have any complete applications then kindly Cancel that. In case you have initiated Payment for any application then kindly contact administrator to Cancel such applications.

Edit Profile

You can now edit your profile. Kindly go to Dashboard to edit respective sections. [Dashboard](#) ×

**Admission  
Open** →

**F.Y.B.A.**

**F.Y.B.Com.**

**F.Y.B.Sc.**

## Contact

9028548210, 8087783220 (Commerce)  
9503002738, 9923139429 (Science)  
7038621729, 9545482101 (Arts)

# Doshi Vakil Arts College and G.C.U.B. Science & Commerce College, Goregaon-Raigad

Click on the particular tab which you want to edit

☰ Welcome PARAG !

ⓘ Please check your profile details once again by clicking on each section before you click on "Profile Confirmation and Apply Online" button on succeeding screens. You will not be able to modify any part of profile (Profile will be locked) once you have applied.  
प्रोफाइल कन्फर्मेशन आणि अप्लाय ऑनलाईन बटनवर क्लिक करण्यापूर्वी आपले संपूर्ण प्रोफाइल (वैयक्तिक, आरक्षण, शैक्षणिक, संपर्क इ.) पुन्हा तपासून घ्या. एकदा ऑनलाईन अर्ज केल्यावर प्रोफाइल मध्ये कुठलाही बदल करता येत नाही.

PersonalDetails

Address

Education

Reservation

PhotoSign

Contact

🔔 Online Application Instructions

- You can apply online only after the completion and confirmation of Profile.  
१. प्रोफाइल पूर्ण भरून स्वीकृत केल्यावरच ऑनलाईन अर्ज करता येईल.
- You can apply for multiple programs in multiple colleges through single login.  
२. एका लॉगिन मधून तुम्ही अनेक अभ्यासकेंद्रात अनेक अभ्यासक्रमास अर्ज करू शकता.
- While applying, if any qualification details are missing, then it may be filled from the Last Qualification screen, even after profile confirmation.  
३. जर एखादी शैक्षणिक माहिती भरावयाची राहिली असल्यास, प्रोफाइल निश्चित झाल्यावरदेखील तुम्ही "शेवटची पात्रता परीक्षा" निवडावयाच्या पानावर भरू शकता.
- Please be careful while applying, once admission gets confirmed in one college then you cannot seek admission in another college in same course.  
४. अर्ज करताना काळजी घ्या. एकदा अभ्यासकेंद्राने प्रवेश निश्चित केल्यावर दुसऱ्या अभ्यासकेंद्रात त्याच अभ्यासक्रमासाठी प्रवेश घेता येत नाही.

🔔 Profile Progress

Confirm Profile Details

Admission  
Open

F.Y.B.A.

F.Y.B.Com.

F.Y.B.Sc.

Contact

9028548210, 8087783220 (Commerce)  
9503002738, 9923139429 (Science)  
7038621729, 9545482101 (Arts)

# Doshi Vakil Arts College and G.C.U.B. Science & Commerce College, Goregaon-Raigad

## Step 2 Completed!

☰ Welcome PARAG !

ⓘ Please check your profile details once again by clicking on each section before you click on "Profile Confirmation and Apply Online" button on succeeding screens. You will not be able to modify any part of profile (Profile will be locked) once you have applied.  
प्रोफाईल कन्फर्मेशन आणि अप्लाय ऑनलाईन बटनवर क्लिक करण्यापूर्वी आपले संपूर्ण प्रोफाईल (वैयक्तिक, आरक्षण, शैक्षणिक, संपर्क इ.) पुन्हा तपासून घ्या. एकदा ऑनलाईन अर्ज केल्यावर प्रोफाईल मध्ये कुठलाही बदल करता येत नाही.



PersonalDetails



Address



Education



Reservation



PhotoSign



Contact

🔔 Online Application Instructions

1. You can apply online only after the completion and confirmation of Profile.  
१. प्रोफाईल पूर्ण भरून स्वीकृत केल्यावरच ऑनलाईन अर्ज करता येईल.
2. You can apply for multiple programs in multiple colleges through single login.  
२. एका लॉगिन मधून तुम्ही अनेक अभ्यासकेंद्रात अनेक अभ्यासक्रमास अर्ज करू शकता.
3. While applying, if any qualification details are missing, then it may be filled from the Last Qualification screen, even after profile confirmation.  
३. जर एखादी शैक्षणिक माहिती भरावयाची राहिली असल्यास, प्रोफाईल निश्चित झाल्यावरदेखील तुम्ही "शेवटची पात्रता परीक्षा" निवडावयाच्या पानावर भरू शकता.
4. Please be careful while applying, once admission gets confirmed in one college then you cannot seek admission in another college in same course.  
४. अर्ज करताना काळजी घ्या. एकदा अभ्यासकेंद्राने प्रवेश निश्चित केल्यावर दुसऱ्या अभ्यासकेंद्रात त्याच अभ्यासक्रमासाठी प्रवेश घेता येत नाही.

🔔 Profile Progress



Confirm Profile Details

# Doshi Vakil Arts College and G.C.U.B. Science & Commerce College, Goregaon-Raigad

## Step 3: Let's Verify your Profile and Apply

Welcome PARAG !

Please check your profile details once again by clicking on each section before you click on "Profile Confirmation and Apply Online" button on succeeding screens. You will not be able to modify any part of profile (Profile will be locked) once you have applied.  
प्रोफाईल कन्फर्मेशन आणि अप्लाय ऑनलाईन बटनवर क्लिक करण्यापूर्वी आपले संपूर्ण प्रोफाईल (वैयक्तिक, आरक्षण, शैक्षणिक, संपर्क इ.) पुन्हा तपासून घ्या. एकदा ऑनलाईन अर्ज केल्यावर प्रोफाईल मध्ये कुठलाही बदल करता येत नाही.

PersonalDetails ✓

Address ✓

Education ✓

Reservation ✓

PhotoSign ✓

Contact ✓

Online Application Instructions

- You can apply online only after the completion and confirmation of Profile.  
१. प्रोफाईल पूर्ण भरून स्वीकृत केल्यावरच ऑनलाईन अर्ज करता येईल.
- You can apply for multiple programs in multiple colleges through single login.  
२. एका लॉगिन मधून तुम्ही अनेक अभ्यासकेंद्रात अनेक अभ्यासक्रमास अर्ज करू शकता.
- While applying, if any qualification details are missing, then it may be filled from the Last Qualification screen, even after profile confirmation.  
३. जर एखादी शैक्षणिक माहिती भरावयाची राहिली असल्यास, प्रोफाईल निश्चित झाल्यावरदेखील तुम्ही "शेवटची पात्रता परीक्षा" निवडावयाच्या पानावर भरू शकता.
- Please be careful while applying, once admission gets confirmed in one college then you cannot seek admission in another college in same course.  
४. अर्ज करताना काळजी घ्या. एकदा अभ्यासकेंद्राने प्रवेश निश्चित केल्यावर दुसऱ्या अभ्यासकेंद्रात त्याच अभ्यासक्रमासाठी प्रवेश घेता येत नाही.

Profile Progress

Confirm Profile Details

Admission  
Open

F.Y.B.A.

F.Y.B.Com.

F.Y.B.Sc.

### Contact

9028548210, 8087783220 (Commerce)  
9503002738, 9923139429 (Science)  
7038621729, 9545482101 (Arts)

# Doshi Vakil Arts College and G.C.U.B. Science & Commerce College, Goregaon-Raigad



Click on the tabs to view the details.

### Profile Summary

Click on DASHBOARD Link and select respective Icon to edit any details

Personal	✓
Contact	✗
Address	✗
Reservation	✗
Education	✗

Model.ABCID.DocumentNumber

Full Name	<b>PARAG SHIMPI</b>	Photograph	Signature
Son Of	<b>SHIVAJI</b>		
Mother's Name	<b>UJALA</b>		
Gender	<b>Male</b>		
Date of Birth	<b>06.07.1984</b>		

Applicant's Name on Statement of Marks/ Leaving Certificate	Name in Regional Language
<b>SHIMPI PARAG SHIMPI</b>	<b>पराग शिवाजी शिंपी</b>
Marital Status	Place of Birth
<b>Married</b>	<b>Jalgaon</b>
Blood Group	ABC ID
---	<b>599-777-482-488</b>
Height	Weight
---	---
First Graduate in Family	Is MartyrFamily
<b>No</b>	<b>No</b>
Education gap (in yrs)	Himoglobin
---	---

**Admission  
Open**



**F.Y.B.A.**

**F.Y.B.Com.**

**F.Y.B.Sc.**

**Contact**  
9028548210, 8087783220 (Commerce)  
9503002738, 9923139429 (Science)  
7038621729, 9545482101 (Arts)

# Doshi Vakil Arts College and G.C.U.B. Science & Commerce College, Goregaon-Raigad

Select the confirmation check box and click on the  
'Confirm Profile and Apply Online' button.

☰ Profile Summary

Click on DASHBOARD Link and select respective Icon to edit any details

Personal	✓
Contact	✓
Address	✓
Reservation	✓
Education	✓

Qualification	Board/University	Institute	Marks/Out of	CGPA	Percentage	Passing Date
SSC/Std 10th	MAHARASHTRA STATE BOARD OF SECONDARY AND HIGHER SECONDARY EDUCATION	LANA HIGHSCHOOL	453 / 650	-	69.69 %	May 1999
HSC/Std 12th [Science]	MAHARASHTRA STATE BOARD OF SECONDARY AND HIGHER SECONDARY EDUCATION	LANA HIGHSCHOOL	453 / 650	-	69.69 %	May 2023

I confirm that I have checked my Personal, Contact, Address, Social, Education details and it is correctly filled by me.

Confirm Profile And Apply Online



Admission  
Open

F.Y.B.A.

F.Y.B.Com.

F.Y.B.Sc.

**Contact**  
9028548210, 8087783220 (Commerce)  
9503002738, 9923139429 (Science)  
7038621729, 9545482101 (Arts)

# Doshi Vakil Arts College and G.C.U.B. Science & Commerce College, Goregaon-Raigad

Select your desired Program using search box  
and click on 'Apply' button

Apply Online

Student wish to apply for Autonomous colleges are requested to select autonomous program. Eg: B.Com. (Autonomous)(with Credits) - Regular - Rev16 - F.Y. B.Com. Sem I. Student wish to admit in regular colleges are requested to select regular program. Eg: B.Com.(with Credits) - Regular - Rev16 - F.Y. B.Com. Sem I  
विद्यार्थ्यांना स्वायत्त (ऑटोनॉमस) महाविद्यालयात प्रवेश अर्ज करावयाचे असल्यास कृपया ऑटोनॉमस अभ्यासक्रम निवडावे. उदा: B.Com. (Autonomous)(with Credits) - Regular - Rev16 - F.Y. B.Com. Sem I. विद्यार्थ्यांना रेगुलर महाविद्यालयात प्रवेश अर्ज करावयाचे असल्यास कृपया नॉन ऑटोनॉमस अभ्यासक्रम निवडावे. उदाहरणार्थ: B.Com.(with Credits) - Regular - Rev16 - F.Y. B.Com. Sem I

Search Programme / अभ्यासक्रम शोधा

Program Code	Program Name (Faculty/College)	Application/Payment dates	Apply
22300001	B.Com.(with Credits) - Regular - Rev16 - F.Y. B.Com. Sem I (Faculty of Commerce)	--- Application Dates --- Start Date : 25/05/2023 17:30:00 End Date : 12/06/2023 23:55:00	Apply

Previous 1 Next

Program Code

Showing 1 to 1 of 1 entries

**COMMERCE : 22300001**      **ARTS : 12300001**      **SCIENCE : 42300001**

# Doshi Vakil Arts College and G.C.U.B. Science & Commerce College, Goregaon-Raigad

Read the Eligibility Criteria and click on  
'Agree' button

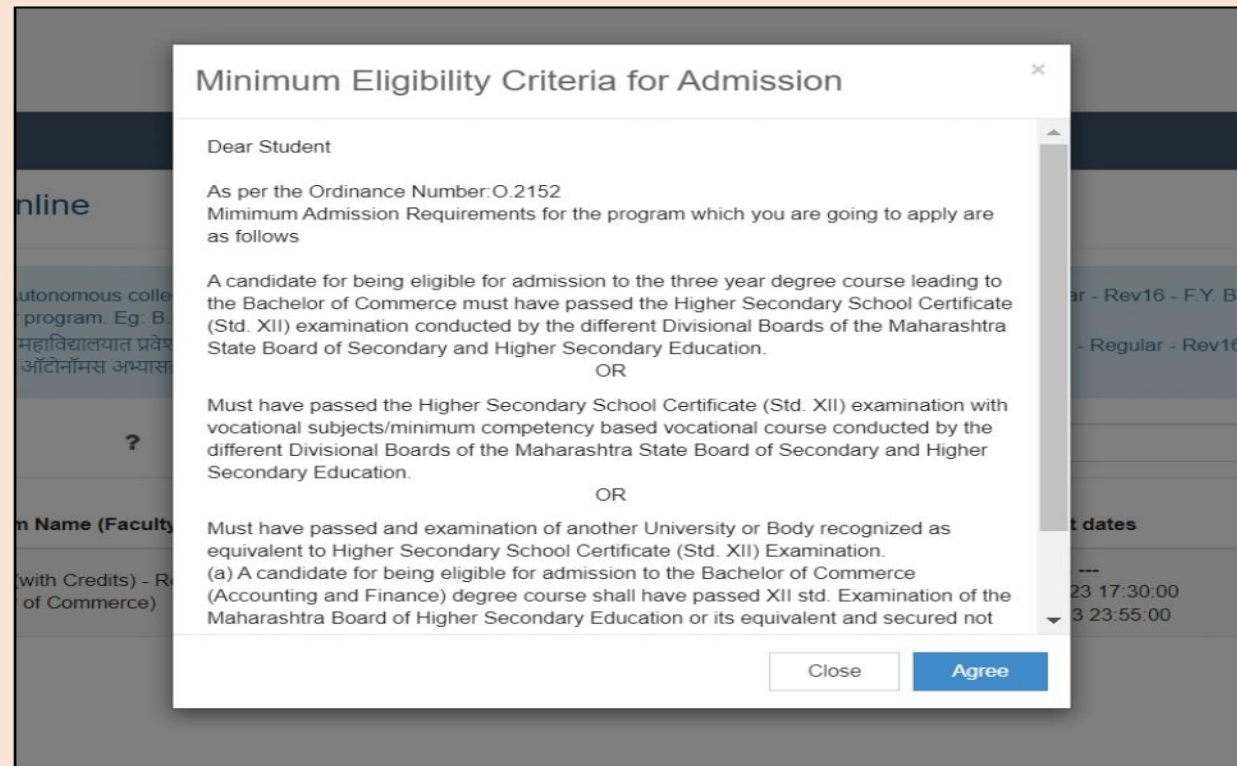

**Minimum Eligibility Criteria for Admission**

Dear Student

As per the Ordinance Number:O.2152  
Minimum Admission Requirements for the program which you are going to apply are as follows

A candidate for being eligible for admission to the three year degree course leading to the Bachelor of Commerce must have passed the Higher Secondary School Certificate (Std. XII) examination conducted by the different Divisional Boards of the Maharashtra State Board of Secondary and Higher Secondary Education.

OR

Must have passed the Higher Secondary School Certificate (Std. XII) examination with vocational subjects/minimum competency based vocational course conducted by the different Divisional Boards of the Maharashtra State Board of Secondary and Higher Secondary Education.

OR

Must have passed and examination of another University or Body recognized as equivalent to Higher Secondary School Certificate (Std. XII) Examination.

(a) A candidate for being eligible for admission to the Bachelor of Commerce (Accounting and Finance) degree course shall have passed XII std. Examination of the Maharashtra Board of Higher Secondary Education or its equivalent and secured not

Close Agree

**Admission  
Open**

**F.Y.B.A.**

**F.Y.B.Com.**

**F.Y.B.Sc.**

## Contact

9028548210, 8087783220 (Commerce)  
9503002738, 9923139429 (Science)  
7038621729, 9545482101 (Arts)



# Doshi Vakil Arts College and G.C.U.B. Science & Commerce College, Goregaon-Raigad

## Select Last Qualifying Exam

☰ Last Qualifying Exam / शेवटची पात्रता परीक्षा निवडा.

Program Name [Code] B.Com.(with Credits) - Regular - Rev16 - F.Y. B.Com. Sem I [22300001]

[+Add Qualification](#)

Qualification	Passing Date	Board/University	Marks	Out of	CGPA	Percentage
<input type="radio"/> SSC/Std 10th	May 1999	MAHARASHTRA STATE BOARD OF SECONDARY AND HIGHER SECONDARY EDUCATION	453	650	-	69.69
<input checked="" type="radio"/> HSC/Std 12th [Science]	May 2023	MAHARASHTRA STATE BOARD OF SECONDARY AND HIGHER SECONDARY EDUCATION	493	750	-	65.73

Preferences

**Want to apply for In-House Seat?**  
 ⓘ [Tick / Select the Check-box, if YES]

**Want to apply for Minority Seat?**  
 ⓘ [Tick / Select the Check-box, if YES]

[Submit](#)

**Admission  
Open**



**F.Y.B.A.**

**F.Y.B.Com.**

**F.Y.B.Sc.**

**Contact**  
9028548210, 8087783220 (Commerce)  
9503002738, 9923139429 (Science)  
7038621729, 9545482101 (Arts)

# Doshi Vakil Arts College and G.C.U.B. Science & Commerce College, Goregaon-Raigad

College  
Code  
503

Select your desired college form the list.  
You can use Filter to search the college.

☰ List of College

Last Qualification saved successfully!

**Program Name [Code]** B.Com.(with Credits) - Regular - Rev16 - F.Y. B.Com. Sem I [22300001]

Select College in which you would like to apply for the selected Program.You can apply to multiple colleges and generate seperate application forms. .  
निवडलेल्या अभ्यासक्रमासाठी अभ्यासकेंद्र शोधा.  
Below displayed colleges are shown from the city of your residence. If you want to apply to the colleges other than your residence city, then use the Search Filter.  
आपल्या शहरातील अभ्यासकेंद्र खाली दाखविलेले आहेत. दुसऱ्या शहरातील अभ्यासकेंद्र हवे असल्यास "सर्च फिल्टर" चा वापर करा.

If you are searching Autonomous college then make sure that, you have selected autonomous program.  
आपण स्वायत्त (ऑटोनॉमस) महाविद्यालय निवडणार असाल तर आपण ऑटोनॉमस अभ्यासक्रम निवडले असल्याची खात्री करा.

? Search Search Filter ▾

District	Tehsil	City	College Name	College Code	Select
		Mira Road (East)	Niranjalal Dalmia Education Society's N.L. Dalmia College	1088	Select
Dadra and Nagar Haveli		Silvassa	Lions Club of Silvassa Charitable Trusts Smt Devkiba Mohansinhji Chauhan College of Commerce and Science	141	Select
Mumbai City	Mumbai	Santacruz (W)	L. S. Raheja College of Arts and Commerce	307	Select

Admission  
Open

F.Y.B.A.

F.Y.B.Com.

F.Y.B.Sc.

## Contact

9028548210, 8087783220 (Commerce)  
9503002738,9923139429 (Science)  
7038621729, 9545482101 (Arts)

# Doshi Vakil Arts College and G.C.U.B. Science & Commerce College, Goregaon-Raigad

Select the appropriate courses for semester-I and  
click on Proceed 'button'

☰ Course Selection / विषय व शिकण्याचे माध्यम निवडा.

**Program Name [Code]** B.Com.(with Credits) - Regular - Rev16 - F.Y. B.Com. Sem I  
**College Name [Code]** Guru Nanak College of Arts, Science and Commerce 75

Medium of Instruction  Marathi  English

**Minimum 7 Course(s) & Maximum 7 Course(s)** should be Selected

**Compulsory Courses Minimum:6 Maximum: 6 [If Applicable]**

- [ UBCOMFSI.1 ] Accountancy and Financial Management I
- [ UBCOMFSI.2 ] Commerce I
- [ UBCOMFSI.3 ] Business Economics I
- [ UBCOMFSI.4 ] Business Communication I
- [ UBCOMFSI.5 ] Environmental Studies I
- [ UBCOMFSI.7 ] Mathematical and Statistical Techniques I

**Elective Course Minimum:1 Maximum: 1 [If Applicable]**

- [ UBCOMFSI.6.1 ] Foundation Course I
- [ UBCOMFSI.6.2 ] Foundation Course in NSS I

Admission  
Open



F.Y.B.A.

F.Y.B.Com.

F.Y.B.Sc.

## Contact

9028548210, 8087783220 (Commerce)  
9503002738, 9923139429 (Science)  
7038621729, 9545482101 (Arts)

# Doshi Vakil Arts College and G.C.U.B. Science & Commerce College, Goregaon-Raigad

Click on 'Add New Term Courses' to select the  
courses for semester-II

☰ Course Summary

Courses saved successfully!

**Program Name [Code]** B.Com.(with Credits) - Regular - Rev16 - F.Y. B.Com. Sem I [22300001]  
**College Name [Code]** Guru Nanak College of Arts, Science and Commerce 75

Sem I

<b>Compulsory Courses</b>	UBCOMFSI.1 - Accountancy and Financial Management I
<b>Compulsory Courses</b>	UBCOMFSI.2 - Commerce I
<b>Compulsory Courses</b>	UBCOMFSI.3 - Business Economics I
<b>Compulsory Courses</b>	UBCOMFSI.4 - Business Communication I
<b>Compulsory Courses</b>	UBCOMFSI.5 - Environmental Studies I
<b>Compulsory Courses</b>	UBCOMFSI.7 - Mathematical and Statistical Techniques I
<b>Elective Course</b>	UBCOMFSI.6.1 - Foundation Course I

Sem II

[Add Next Term Course](#) 

[Proceed](#)

Admission  
Open

F.Y.B.A.

F.Y.B.Com.

F.Y.B.Sc.

## Contact

9028548210, 8087783220 (Commerce)  
9503002738, 9923139429 (Science)  
7038621729, 9545482101 (Arts)

# Doshi Vakil Arts College and G.C.U.B. Science & Commerce College, Goregaon-Raigad

Click on Proceed button

☰ Course Summary

Courses saved successfully!

**Program Name [Code]** B.Com.(with Credits) - Regular - Rev16 - F.Y. B.Com. Sem I [22300001]  
**College Name [Code]** Guru Nanak College of Arts, Science and Commerce 75

Sem I

<b>Compulsory Courses</b>	UBCOMFSI.1 - Accountancy and Financial Management I
<b>Compulsory Courses</b>	UBCOMFSI.2 - Commerce I
<b>Compulsory Courses</b>	UBCOMFSI.3 - Business Economics I
<b>Compulsory Courses</b>	UBCOMFSI.4 - Business Communication I
<b>Compulsory Courses</b>	UBCOMFSI.5 - Environmental Studies I
<b>Compulsory Courses</b>	UBCOMFSI.7 - Mathematical and Statistical Techniques I
<b>Elective Course</b>	UBCOMFSI.6.1 - Foundation Course I

Sem II

<b>Compulsory Courses</b>	UBCOMFSII.1 - Accountancy and Financial Management II
<b>Compulsory Courses</b>	UBCOMFSII.2 - Commerce II
<b>Compulsory Courses</b>	UBCOMFSII.3 - Business Economics II
<b>Compulsory Courses</b>	UBCOMFSII.4 - Business Communication II
<b>Compulsory Courses</b>	UBCOMFSII.5 - Environmental Studies II
<b>Compulsory Courses</b>	UBCOMFSII.7 - Mathematical and Statistical Techniques II
<b>Elective Course</b>	UBCOMFSII.6.1 - Foundation Course II

Proceed

Admission  
Open

F.Y.B.A.

F.Y.B.Com.

F.Y.B.Sc.

## Contact

9028548210, 8087783220 (Commerce)  
9503002738, 9923139429 (Science)  
7038621729, 9545482101 (Arts)

# Doshi Vakil Arts College and G.C.U.B. Science & Commerce College, Goregaon-Raigad

Select the required document which you have to submit to the selected 'college'

☰ Documents/Certificates Submitting with Application Form

**Program Name [Code]** B.Com.(with Credits) - Regular - Rev16 - F.Y. B.Com. Sem I [22300001]  
**College Name [Code]** Guru Nanak College of Arts, Science and Commerce 75

**Required Documents**

Please select required documents to be submitted in College

**Document**

Passing Certificate of Std 12th / Statement of Marks of Std 12th OR Original Passing Certificate /Statement of Marks of Last Qualifying Exam like degree,diploma,etc. - HSC/Std 12th [Science]

**Additional Documents**

**Document**

Passing Certificate of Std 10th.

Leaving Certificate.

Certificate of Caste with Category.

Non Creamy Layer Certificate.

Affidavit for changed name/ Marriage Certificate / Govt. Gazette.

Domicile Certificate.

Certificate for Physically Challenged.

**Admission  
Open**

**F.Y.B.A.**

**F.Y.B.Com.**

**F.Y.B.Sc.**

## Contact

9028548210, 8087783220 (Commerce)  
9503002738,9923139429 (Science)  
7038621729, 9545482101 (Arts)

# Doshi Vakil Arts College and G.C.U.B. Science & Commerce College, Goregaon-Raigad

Application completed successfully  
Please note the application number.

Application Status

CONGRATULATIONS! You have successfully completed the application. Please Note your APPLICATION FORM no:1.

If you want to apply for another college with same course, just click on DASHBOARD link then APPLY ONLINE button and proceed further.

If you want to apply for another course, just click on **DASHBOARD** link then APPLY ONLINE button and proceed further.

List of Application

Form No.	College	Program	Date	Status	Payment	Admission Fee Payment	Print Application Form	Print Admission Form	Cancel
1	Guru Nanak College of Arts, Science and Commerce [75]	B.Com.(with Credits)-Regular-Rev16-F.Y. B.Com.-Sem I	25-05-2023	Completed					

Admission  
Open



F.Y.B.A.

F.Y.B.Com.

F.Y.B.Sc.

## Contact

9028548210, 8087783220 (Commerce)  
9503002738, 9923139429 (Science)  
7038621729, 9545482101 (Arts)

# Doshi Vakil Arts College and G.C.U.B. Science & Commerce College, Goregaon-Raigad

Step 4: Print the Application form and submit it to the college which you have selected.

☰ Application Status

CONGRATULATIONS! You have successfully completed the application. Please Note your APPLICATION FORM no:1. ×

📌 If you want to apply for another college with same course, just click on DASHBOARD link then APPLY ONLINE button and proceed further. ×

📌 If you want to apply for another course, just click on **DASHBOARD** link then APPLY ONLINE button and proceed further.

List of Application

Form No.	College	Program	Date	Status	Payment	Admission Fee Payment	Print Application Form	Print Admission Form	Cancel
1	Guru Nanak College of Arts, Science and Commerce [75]	B.Com.(with Credits)-Regular-Rev16-F.Y. B.Com.-Sem I	25-05-2023	Completed			<b>Print</b>		

**Admission Open** → **F.Y.B.A.** **F.Y.B.Com.** **F.Y.B.Sc.**

**Contact**  
9028548210, 8087783220 (Commerce)  
9503002738, 9923139429 (Science)  
7038621729, 9545482101 (Arts)





# Doshi Vakil Arts College and G.C.U.B. Science & Commerce College, Goregaon-Raigad

Save and Print the Application by clicking on Print Application' button



**UNIVERSITY OF MUMBAI**  
M.G.Road, Fort, Mumbai-400032, Maharashtra(India)





PARAG 

DASHBOARD GET HELP ONLINE VIDEOS

D23CQ0000004 View Profile Application Status Receipt/Transaction Details Edit Profile Print e-Suvidha Ticket Update Awaited Results



Back Print Application

	<b>Guru Nanak College of Arts, Science and Commerce (75)</b> Guru Tegh Bahadur Nagar, Panjabi Colony. Mumbai <b>University of Mumbai</b> M.G.Road, Fort, Mumbai-400032, Maharashtra(India) Academic Year: 2023-2024 <b>APPLICATION FORM</b>	<b>Application No : 1 Regular</b> 
Course Applied for : <b>B.Com.(with Credits) - Regular - Rev16 - F.Y. B.Com. Sem I (22300001)</b>		ABC ID: 595 777 402 400
Application Date : 25/05/2023		PRN:
<b>1.Personal Information</b>		
Candidate's Name(Regional) :		
Candidate's Name as printed on Mark sheet :		
Father's/Husband's Name :		
Marital Status :		
Place Of Birth : Jalgaon		
Gender : Male		Date of Birth (DD/MM/YYYY) : 06/07/1998
Religion :		Country of Citizenship : India

<https://mumoa.digitaluniversity.ac/ApplicationStatus/PrintApplication#>

Admission Open

F.Y.B.A.

F.Y.B.Com.

F.Y.B.Sc.

**Contact**  
 9028548210, 8087783220 (Commerce)  
 9503002738,9923139429 (Science)  
 7038621729, 9545482101 (Arts)

# Doshi Vakil Arts College and G.C.U.B. Science & Commerce College, Goregaon-Raigad

Thank You!

Admission  
Open

F.Y.B.A.

F.Y.B.Com.

F.Y.B.Sc.

## Contact

9028548210, 8087783220 (Commerce)  
9503002738, 9923139429 (Science)  
7038621729, 9545482101 (Arts)